

Notes:

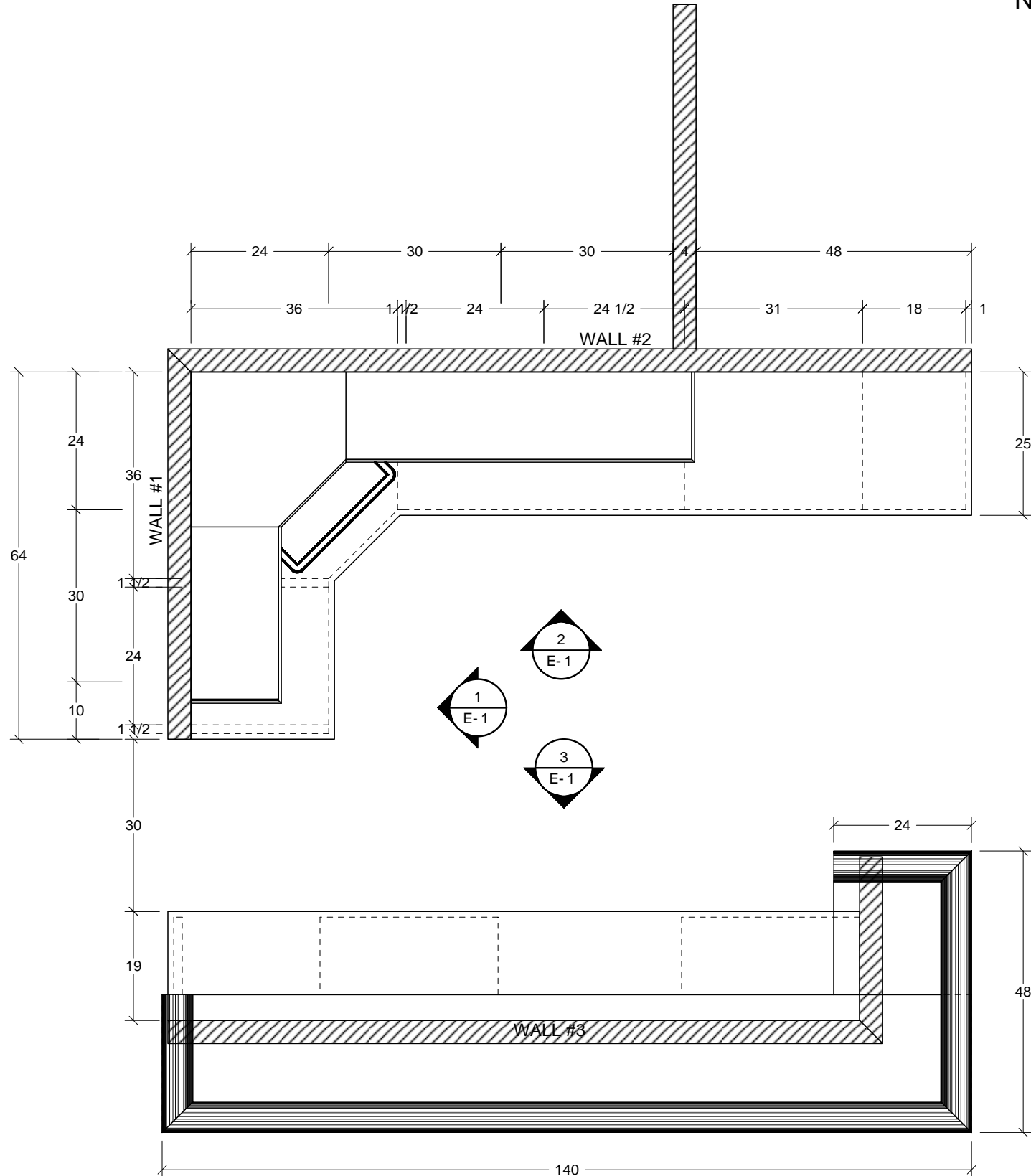

1 Plan View  
Scale: 1/2" = 1'



One on One Design Solutions  
P.O. Box 3935  
Wilson, NC 27895  
1.800.283.3037  
www.1on1designsolutions.com

APPROVAL SIGNATURE	
<input type="checkbox"/>	APPROVED
<input type="checkbox"/>	AS NOTED
SIGNATURE:	
DATE:	

Revisions:		
No.	Date	Description

Project : Smith Bar  
  
Project Number : 19-104  
Date Drawn : 9/13/12  
Drawn By : Gordon Robinson  
One on One Design Solutions  
www.1on1ds.com

Scale : As Noted  
Paper Size : B (11" x 17")

Drawing Title:  
**Plan View**

Revision	Drawing Number
0	P-1



One on One Design Solutions  
 P.O. Box 3935  
 Wilson, NC 27895  
 1.800.283.3037  
 www.1on1designsolutions.com

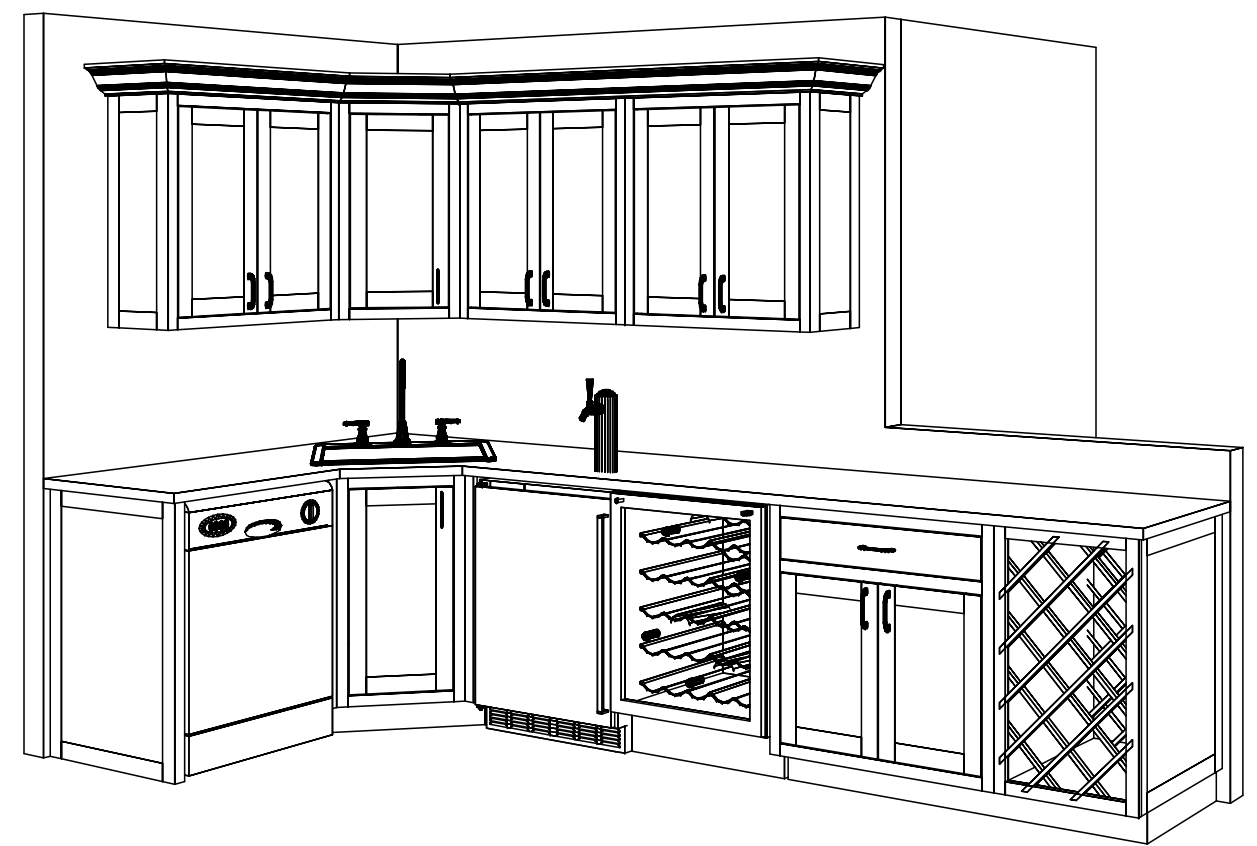
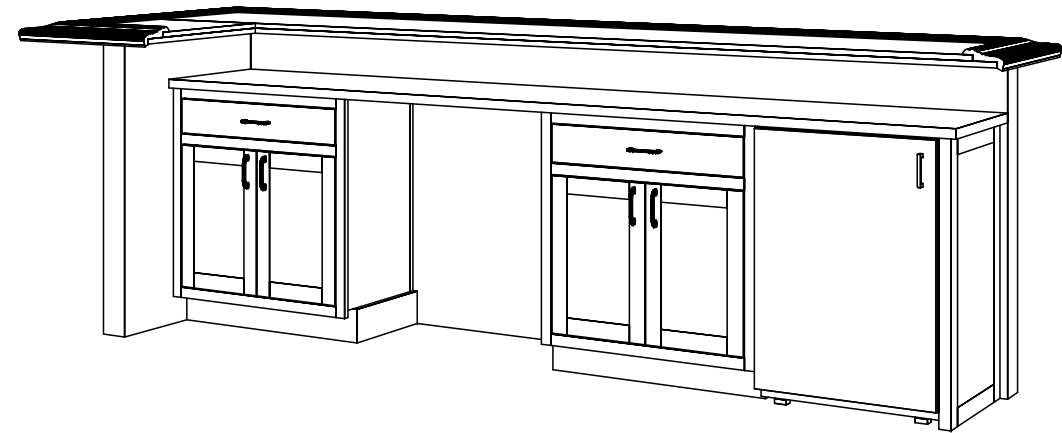
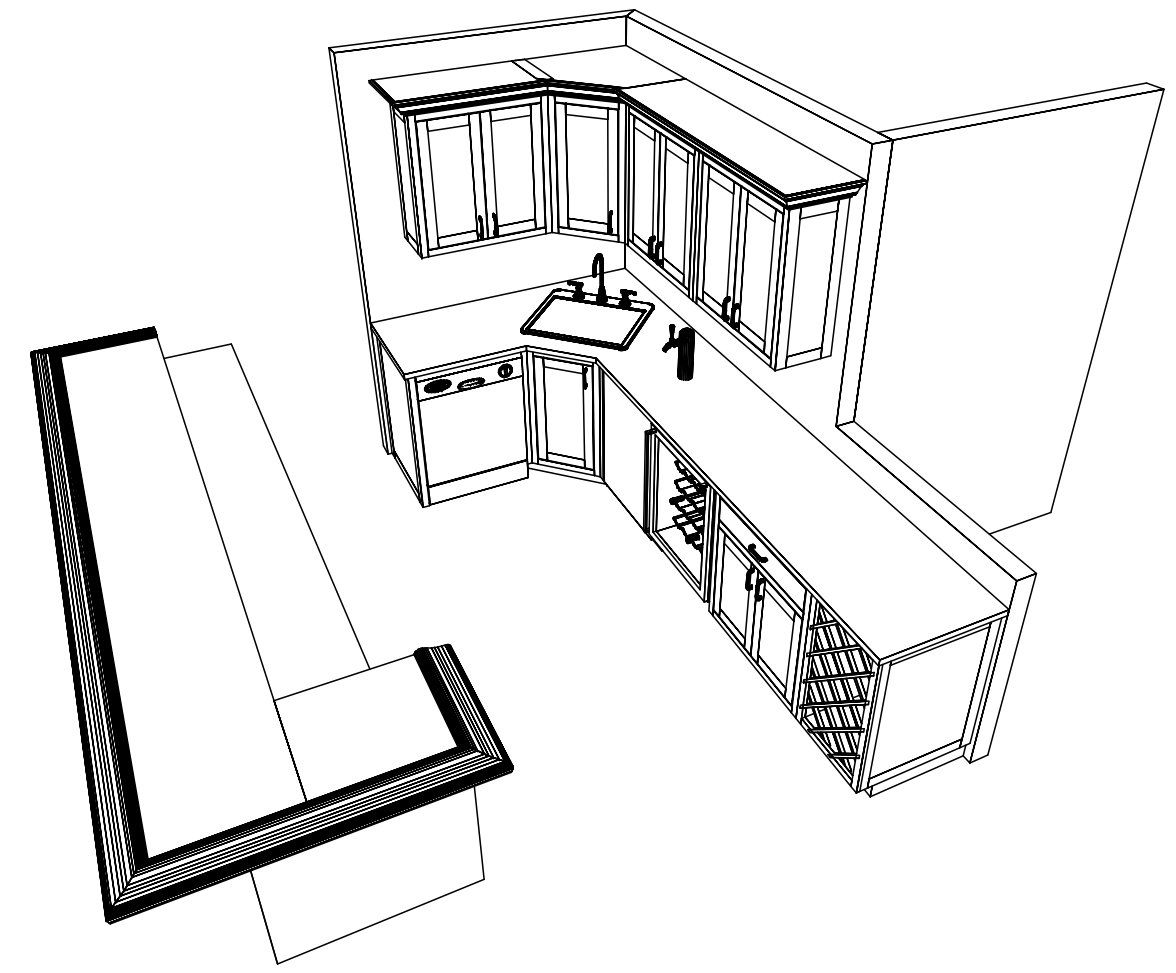

**APPROVAL SIGNATURE**

- APPROVED
- AS NOTED

SIGNATURE: \_\_\_\_\_

DATE: \_\_\_\_\_

**Revisions:**

No. Date Description

Project : Smith Bar

Project Number : 19-104

Date Drawn : 9/13/12

Drawn By : Gordon Robinson  
 One on One Design Solutions  
 www.1on1ds.com

Scale : As Noted

Paper Size : B (11" x 17")

Drawing Title:  
**3D Perspective Views**

Revision	Drawing Number
0	P-1.1



One on One Design Solutions  
 P.O. Box 3935  
 Wilson, NC 27895  
 1.800.283.3037  
 www.1on1designsolutions.com

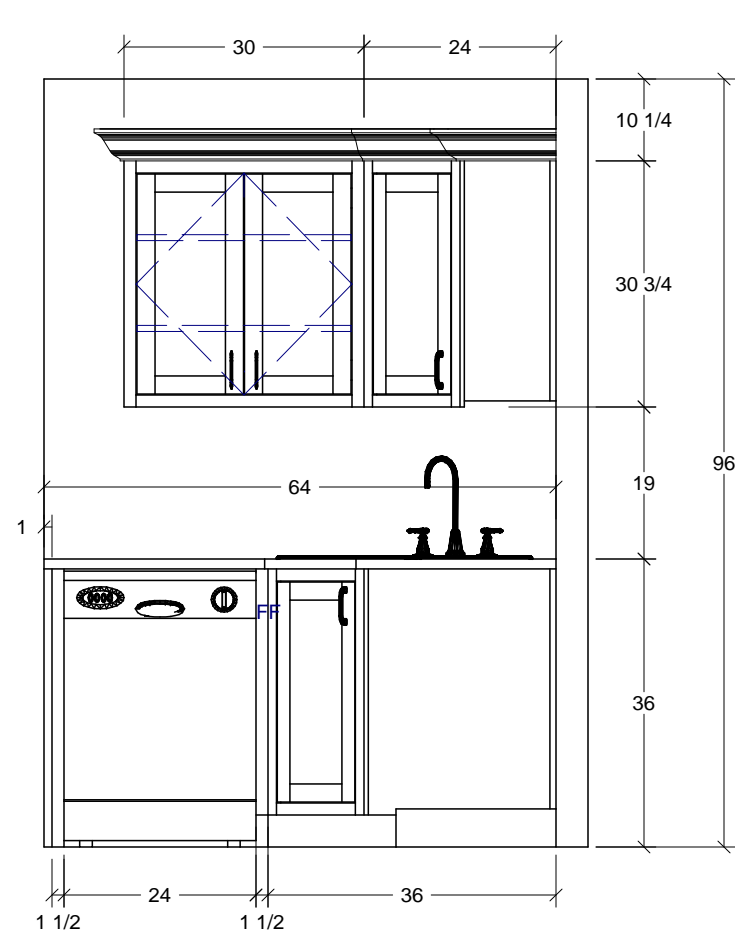

**1** Elevation Wall 1  
 Scale: 1/2" = 1'

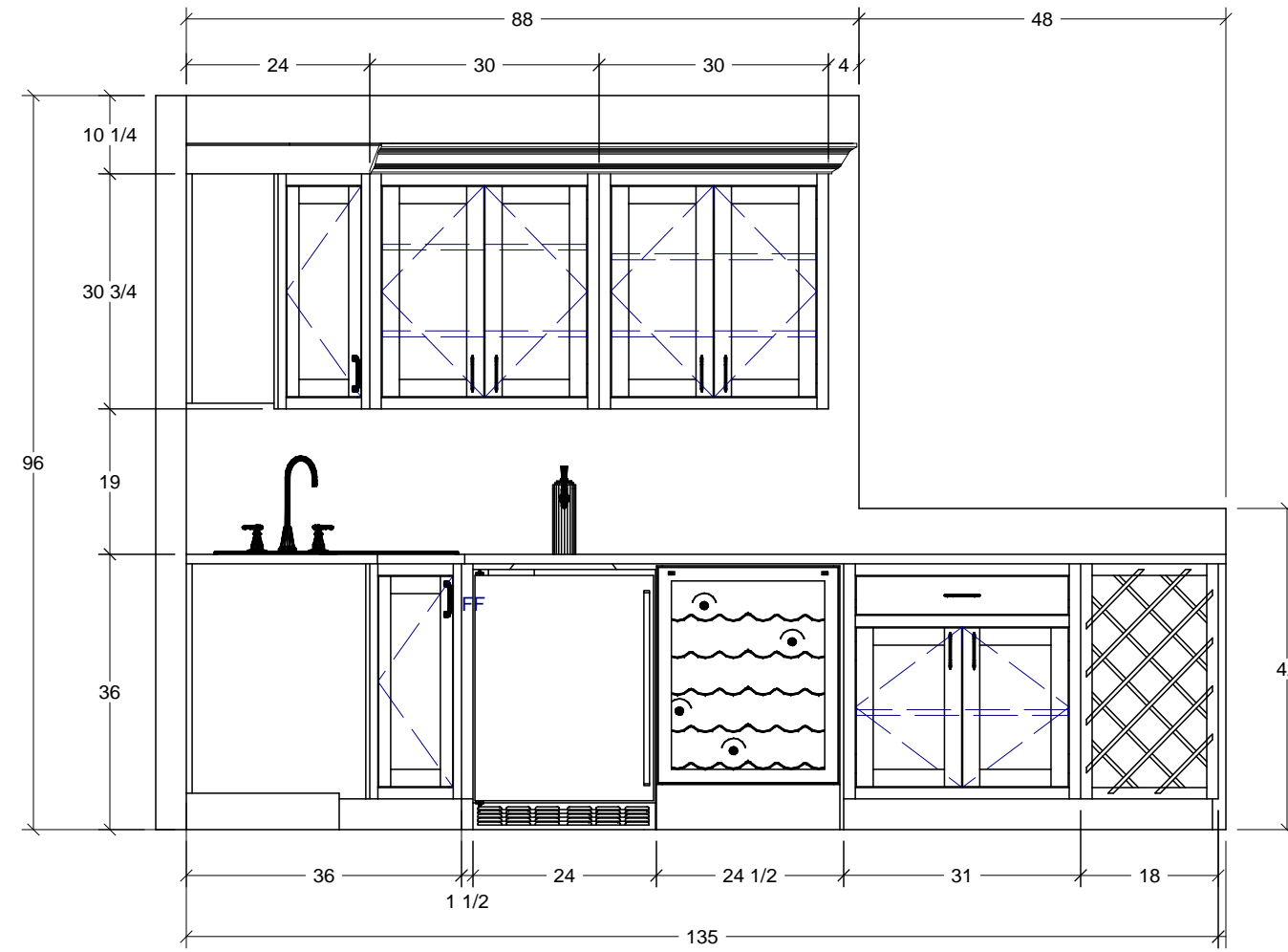

**2** Elevation Wall 2  
 Scale: 1/2" = 1'

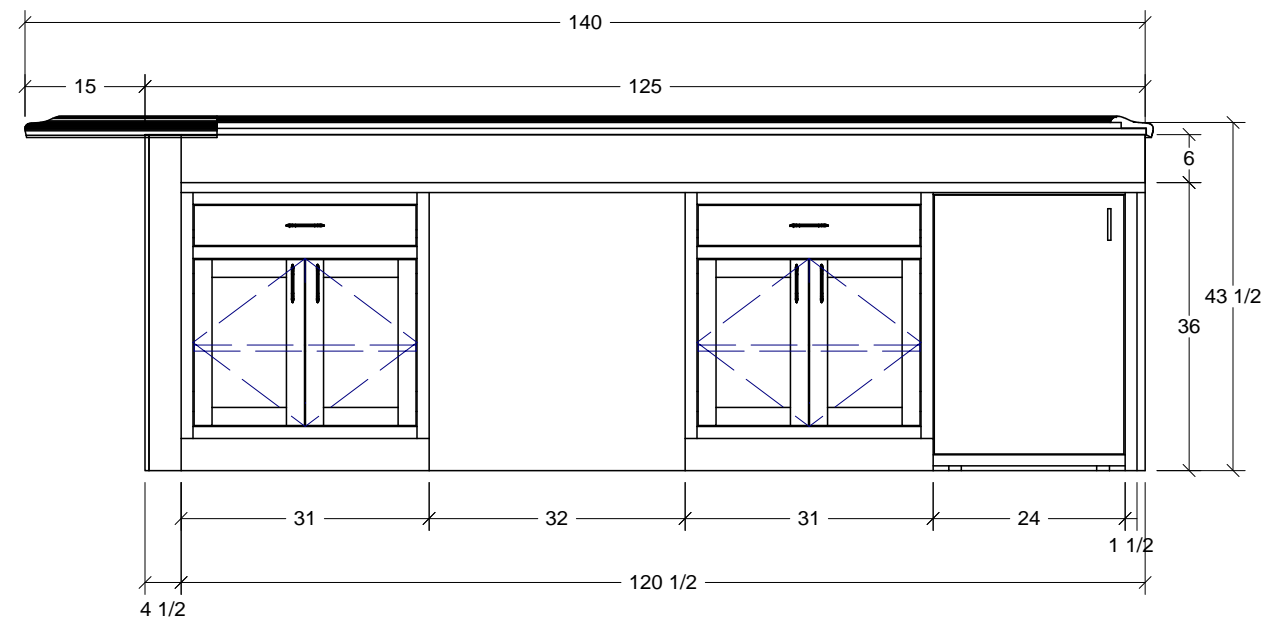

**3** Elevation Back of Front Bar  
 Scale: 1/2" = 1'

APPROVAL SIGNATURE	
<input type="checkbox"/>	APPROVED
<input type="checkbox"/>	AS NOTED
SIGNATURE:	
DATE:	

Revisions:		
No.	Date	Description

Project : Smith Bar  
 Project Number : 19-104  
 Date Drawn : 9/13/12  
 Drawn By : Gordon Robinson  
 One on One Design Solutions  
 www.1on1ds.com

Scale : As Noted  
 Paper Size : B (11" x 17")

Drawing Title: <b>Bar Elevations</b>	
Revision	Drawing Number
0	E-1